

* Pentru proiectul final de montaj, va recomandam sa consultati un proiectant zonal care sa cunoasca caracteristicile de teren si climatice specifice zonei de montaj.

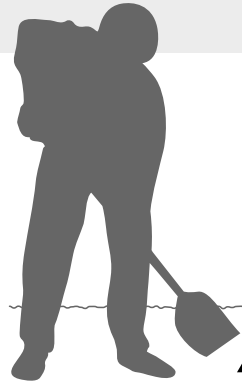

6 m = 80 cm
8 m = 90 cm
10 m = 100 cm
12 m = 120 cm

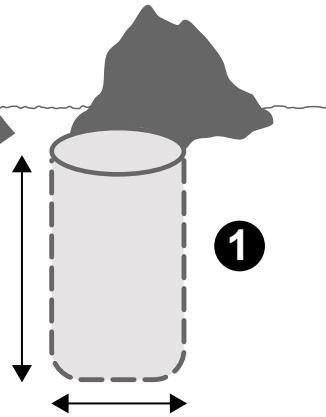

1

6 m = Ø 40 cm
8 m = Ø 45 cm
10 m = Ø 50 cm
12 m = Ø 60 cm

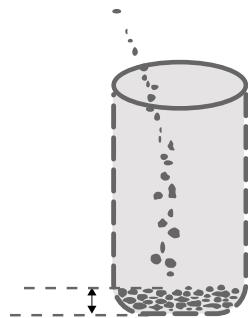

2

Turnati aprox. 5cm de pietris pe fundul gropii

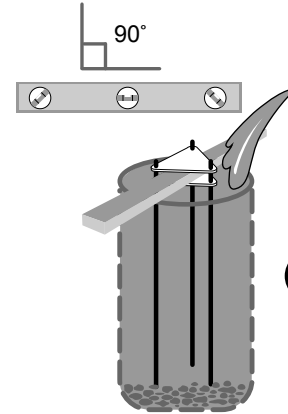

3

Pozitioneaza ancorele de fundatie si talpa metalica cu aprox. 2cm deasupra gropii.
Umpleti groapa cu beton.

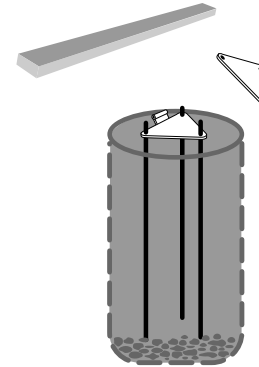

4

Fixati cuiul sistemului rabatabil, ridicati catargul si strangeti suruburile.



5

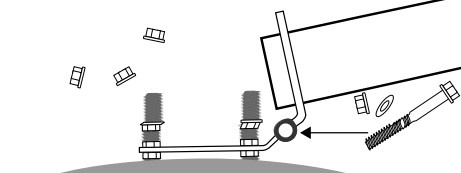

Ajusteaza suruburile pentru a pozitiona perfect vertical catargul.

6

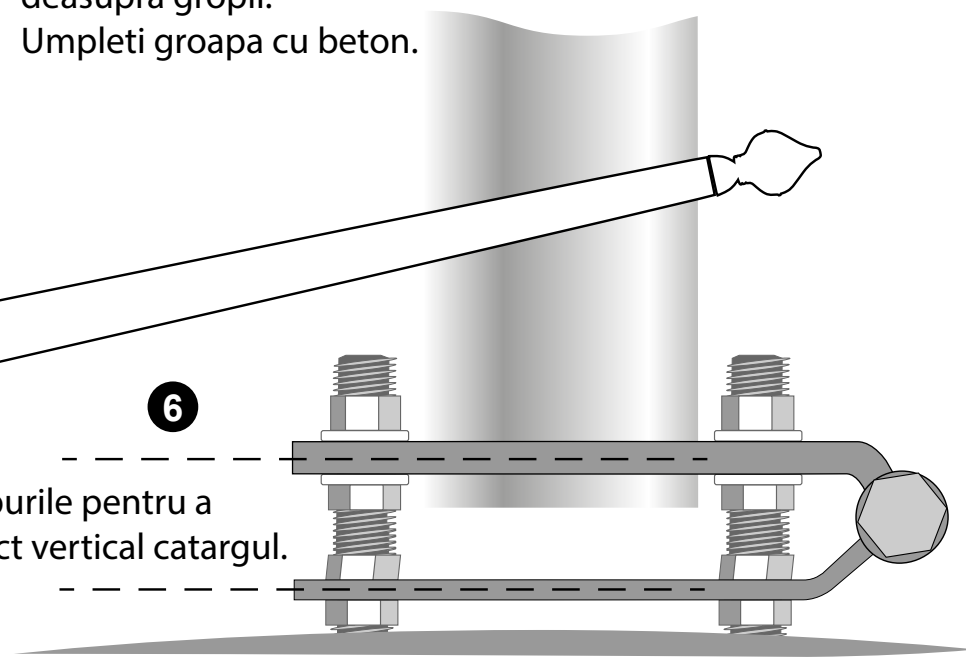

* Pentru proiectul final de montaj, va recomandam sa consultati un proiectant zonal care sa cunoasca caracteristicile de teren si climatice specifice zonei de montaj.

* - in functie de inaltimea catargelor din AL (130mm pentru 6-9m, 180mm pentru 10-12m)

