



www.profilepolistiren.fordesign.ro

mail: office@fordesign.ro

Pentru comenzi suna la 0732 760 660



**DECORATIUNI DIN
POLISTIREN 2011**

FOR DESIGN este sursa ta de ornamente arhitecturale care te ajuta sa-ti transformi proiectul de constructie și sa-ti crezi un design exterior si interior impresionant si unic, folosind profilele noastre decorative din polistiren destinate decorarii fatadelor cladirilor pana la coloanele decorative, baghetele sau scafele ornamentale. Ele vin sa accentueze într-un stil elegant, modern sau aristocratic, interiorul sau exteriorul locuintei dumneavoastra.

FOR DESIGN produce pentru domeniul constructiilor si amenajarilor interioare o gama foarte variata de profile decorative din polistiren de orice forma si dimensiune, folosind un sistem computerizat de mare precizie care permite modelarea polistirenului expandat de inalta densitate (EPS 100, EPS 200), polistiren extrudat (XPS) obtinand astfel cele mai variate forme pentru ancadramentele usilor si ferestrelor, solbancuri si socluri, chei de bolta, medalioane, brauri decorative sau cornise, obloane false sau balustrii si beneficiind de multe alte avantaje evidente ale acestui material.

Profilul de polistiren este rezistent, usor si simplu de instalat datorita flexibilitatii prin care se poate monta. Profilele de polistiren se pot monta cu usurinta inclusiv pe suporturi curbate sau denivelate.

Prin acoperirea noastra cu un strat polimeric cuartos, profilul de polistiren devine dur si rezistent la impact, intemperii si raze UV. Costurile reduse si timpul de executie sunt doar cateva din avantajele utilizarii profilelor ornamentale decorative.

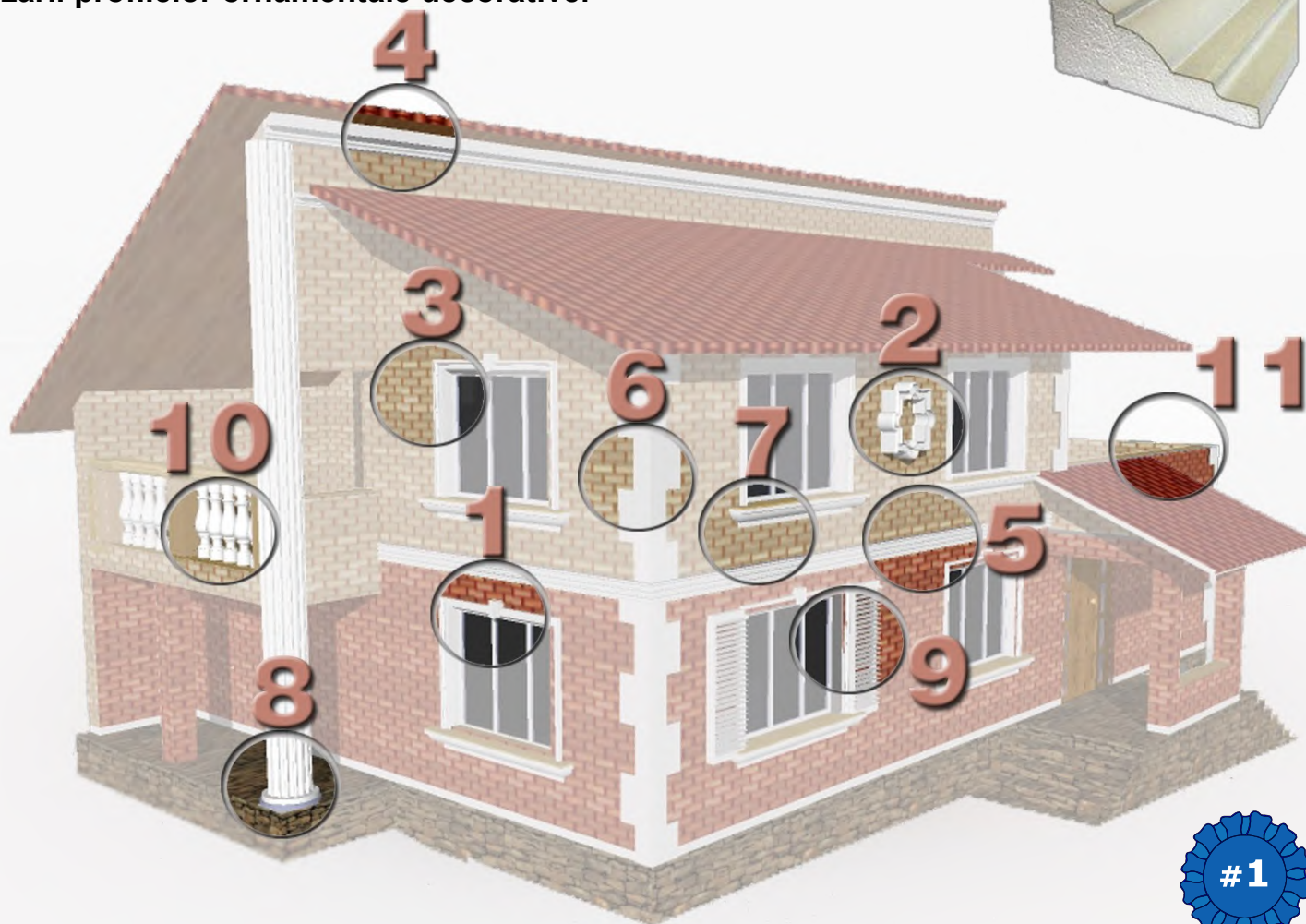

Cuprins

1. Chei de bolta		11. Capete zid	
2. Medalioane		12. Semnalistica	
3. Ancadramente		13. Scafe	
4. Cornise		14. Capiteluri	
5. Brauri		15. Suporti, console	
6. Coltare		16. Capete de stalp	
7. Solbancuri		17. Izolatori tevi	
8. Coloane		18. Baghete de interior	
9. Obloane false		19. Litere volumetrice	
10. Balustri		20. Ornamente de sarbatori	

CHEI DE BOLTA

Elemente arhitecturale pentru ornarea partii superioare a ferestrelor.



FDCH-001



FDCH-002

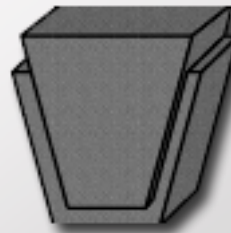

MEDALIOANE

Elemente arhitecturale pentru ornarea peretilor.



FDM-001



FDM-002



IZOLATORI TEVI

Elemente folosite pentru izolarea tevilor de orice dimensiuni, montarea realizandu-se prin clipsare.



FDT-001



ANCADRAMENTE

Elemente arhitecturale pentru incadrare usilor si ferestrelor intr-un chenar decorativ in relief care le inconjoara.



FDA-001



FDA-002

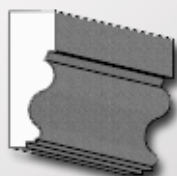

FDA-003



FDA-004



FDA-005



FDA-006



FDA-007

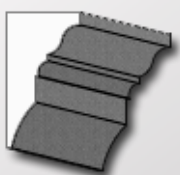

FDA-008

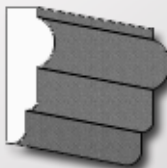

FDA-009



FDA-010

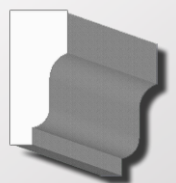

FDA-011



FDA-0xx



CORNISE

Elemente arhitecturale aflate in partea superioară a zidului cu rolul de a împiedica scurgerea apei de ploaie pe fatada cladirilor.



FDC-001



FDC-002



FDC-003

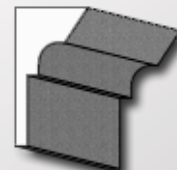

FDC-004



FDC-005



FDC-006

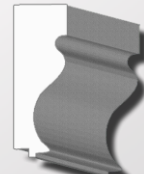

FDC-007



FDC-008

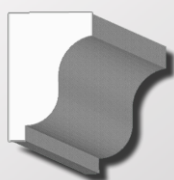

FDC-009

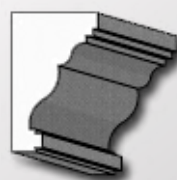

COLTARE

Elemente arhitecturale pentru ornarea colturilor exterioare a doi pereti



FDCT-001

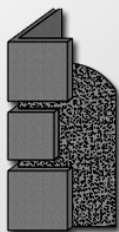

FDCT-002



BRAURI

Elemente arhitecturale ce inconjoara o cladire sau sunt folosite pentru delimitarea etajelor.



FDB-001

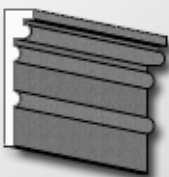

FDB-002

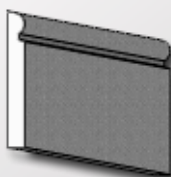

FDB-003



FDB-004

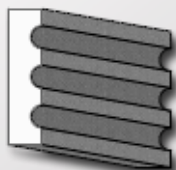

FDB-005

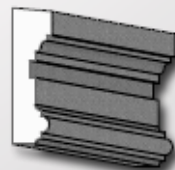

SOLBANCURI

Elemente arhitecturale pentru protejarea parapetilor de sub ferestre de scurgerea apei de ploaie.



FDS-001



FDS-002

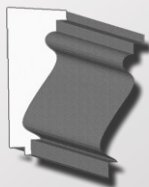

FDS-003



FDS-004



FDS-005



FDS-0XX



COLOANE

Elemente arhitecturale pentru ornarea stalpilor sau incadrarea usilor.



FDCL-001



FDCL-002



Tipuri de coloane:



Intregi decupate in interior,
intregi, 3/4, 1/2, diverse forme

OBLOANE FALSE

Elemente arhitecturale pentru ornarea ferestrelor.



FDO-001

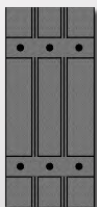

FDO-002



FDO-003

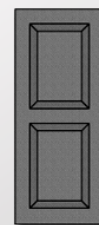

CAPETE DE ZID

Elemente arhitecturale aflate in partea superioara a zidurilor sau a gardurilor.



FDCPT-001



FDCPT-002



FDCPT-003

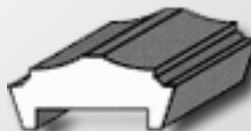

FDCPT-004

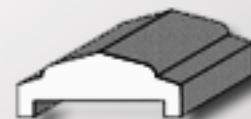

SEMNALISTICA

Elemente arhitecturale pentru semnalizare parcuri, localitati, institutii, monumente, etc.



FDM-001

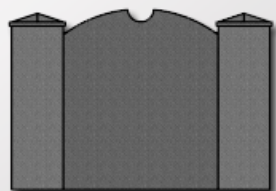

FDM-002

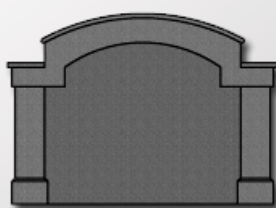

FDM-003



SCAFE

Elemente interioare ce pot fi iluminate. Se folosesc , in special la tavane pentru a ascunde corpurile de iluminat.



FDSCF-001



BALUSTRI

Elemente arhitecturale pentru ornarea balcoanelor, crearea de balcoane false.



FDB-001



FDB-002



FDB-003



CAPITEL

Elemente arhitecturale aflate in partea superioara si inferioara a coloanelor.



FDSP-001



FDSP-002

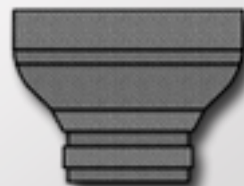

FDSP-003



FDSP-004



FDSP-005



FDSP-006



FDSP-007

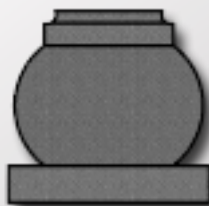

FDSP-008



SUPORTI & CONSOLE

Elemente decorative folosite cu scopul de a crea idea de sustinere.



FDSP-001



FDSP-002



FDSP-003



CAPETE DE STALP

Elemente arhitecturale aflate in partea superioara a stalpilor (garduri, balcoane, etc).



FDST-001

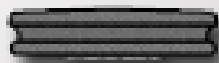

FDST-002



FDST-003



BAGHETE INTERIOARE

Elemente arhitecturale ce finiseaza colturile interioare sau delimiteaza suprafete de perete.



FDINT-001

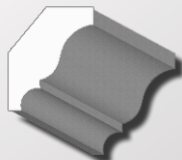

FDINT-002

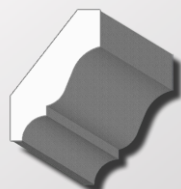

FDINT-003

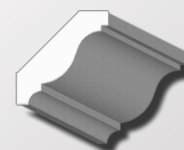

FDINT-004



FDINT-005

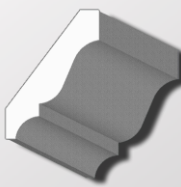

FDINT-006

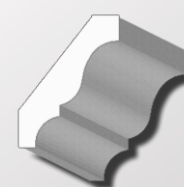

FDINT-007

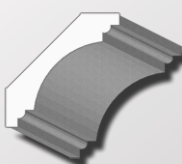

FDINT-008

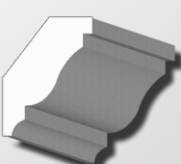

FDINT-009

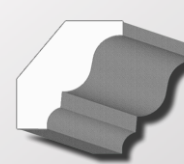

Litere volumetrice, sigle, numere de casa, etc.



Litere
Volumetrice

4d

Sigle



Numere de
casa



Elemente decorative
pentru sarbatori sau ocazii speciale, orice dimensiune.



Ghid de instalare a profilelor FOR DESIGN

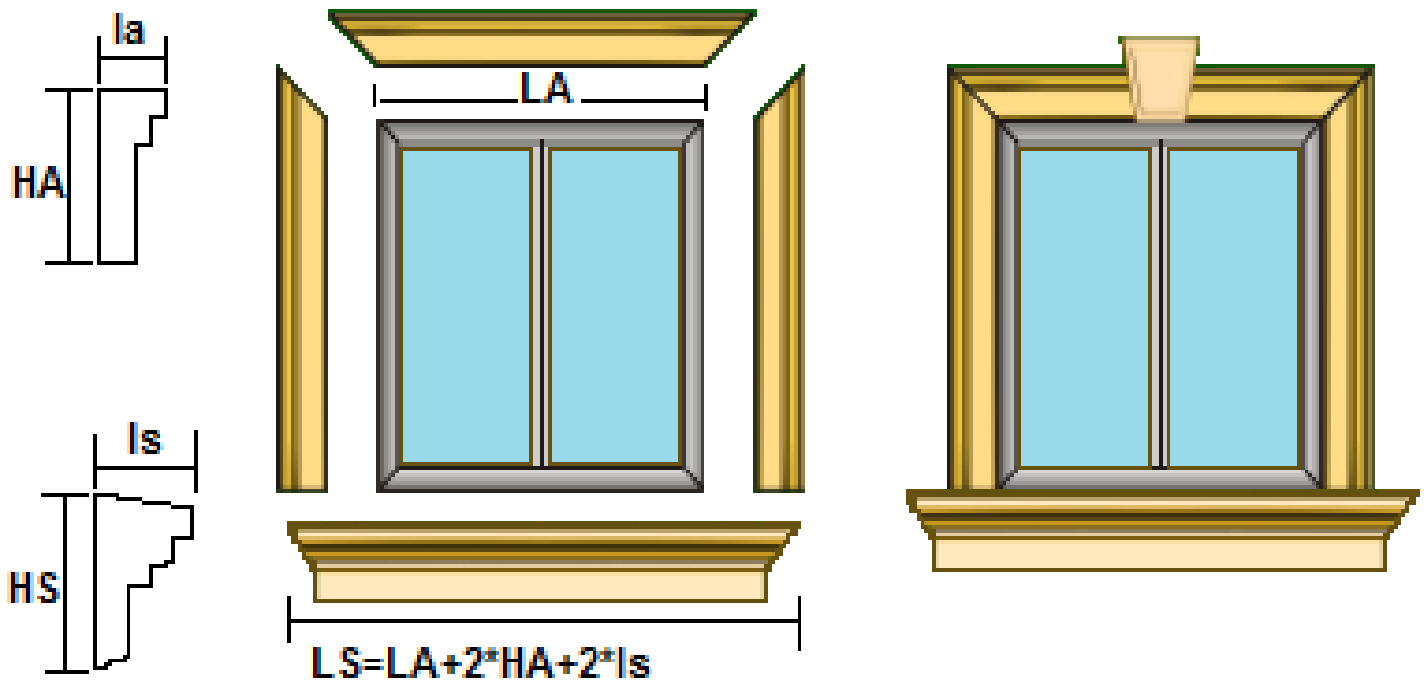

Instalarea se va face la o temperatura ambianta de minim 5 grade, cu adezivi specifici polistirenului expandat pe suprafete curate fara urme de grasimi sau alte substante.

Aplicarea se face conform figurilor alaturate incepand cu montarea pervazelor la ferestre, sau a colturilor la cornise.

Pana la uscarea adezivilor se recomanda fixarea mecanica cu ajutorul unor cuie sau suruburi, urmand ca mai tarziu acestea sa fie inlaturate iar urmele lasate de acestea sa fie chituite.

Indepartati surplusul de adeziv inainte de uscarea acestuia.

Dupa instalare acestea nu necesita amorsare sau alte operatii inainte de vopsire cu orice vopsea lavabila de exterior.

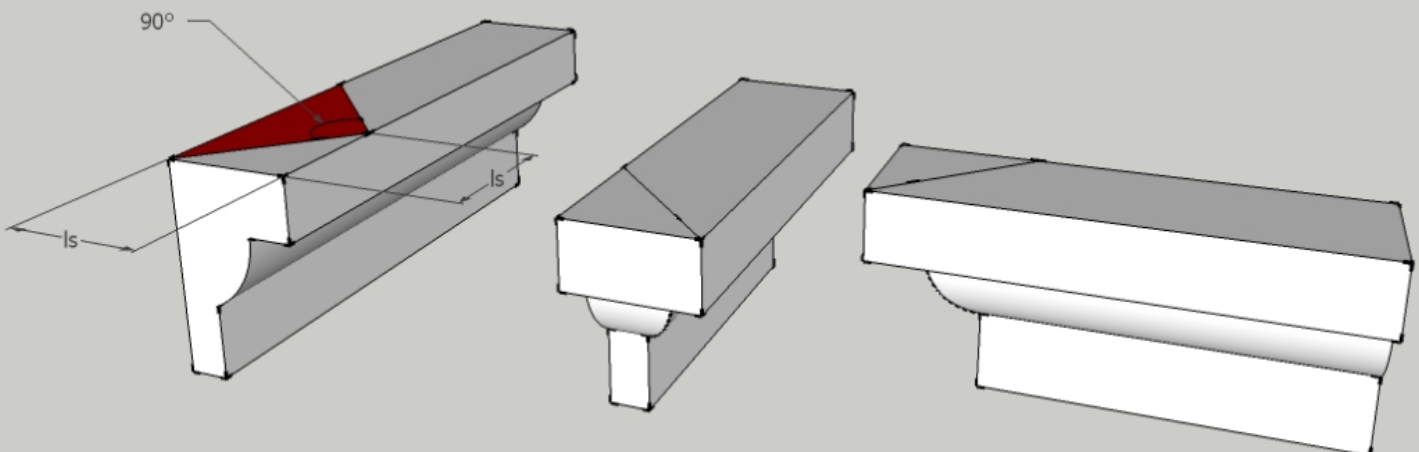

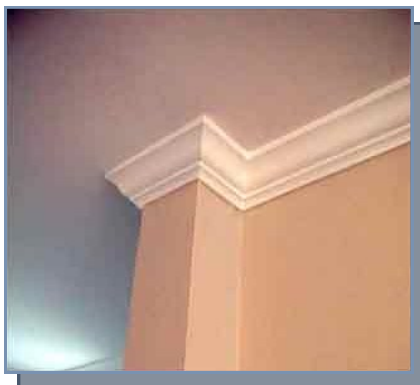
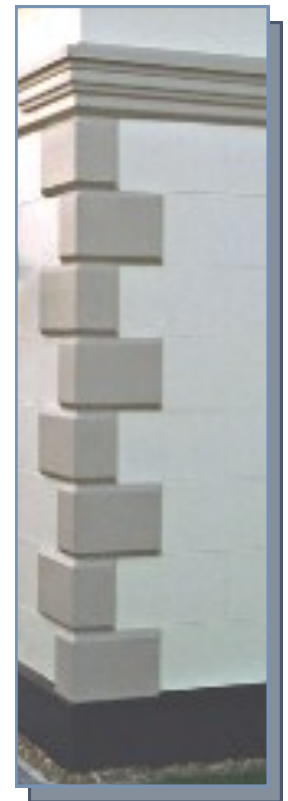
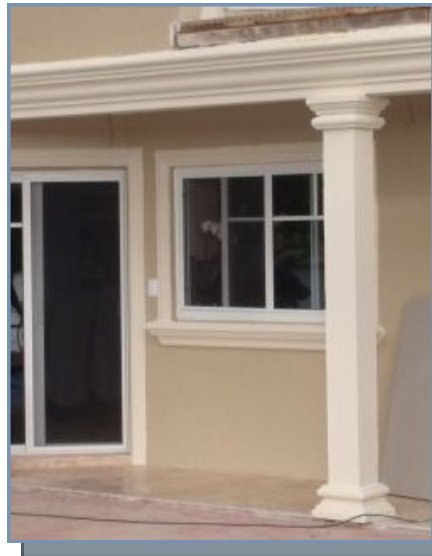

www.profilepolistiren.fordesign.ro

mail: office@fordesign.ro

Pentru comenzi suna la 0732 760 660



DECORATIUNI DIN
POLISTIREN 2011